

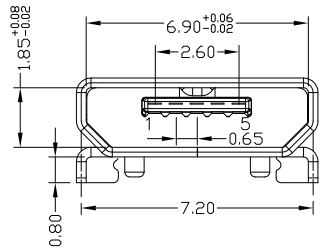

RoHS  
Compliant  
2002/95/EC

Halogen Free

REV.	ECN.	NO.	APPD.

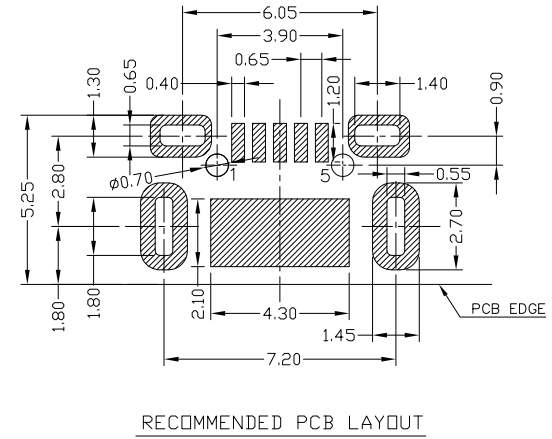
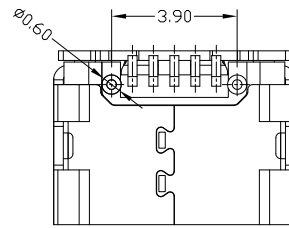
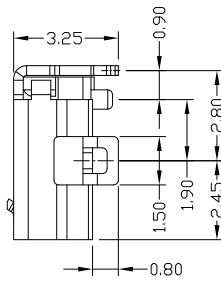
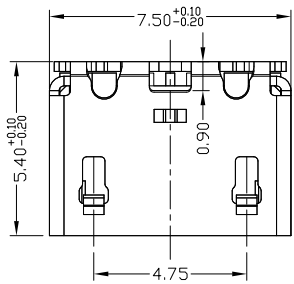
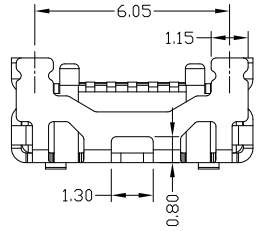

NOTES:

1.ELECTRICAL:

- 1)VOLTAGE CURRENT RATING: PIN1&5 1.8AMP MAX / PIN2&3&4 1AMP MAX. ,30V AC;
- 2)INSULATION RESISTANCE: 100MΩ MIN;
- 3)CONTACT RESISTANCE: 30mΩ MAX;
- 4)WITHSTANDING VOLTAGE: 100V AC; FOR 1 MIN.
- 5)OPERATING TEMPERATURE: -30°C TO +80°C.

2.Mechanical:

- 1)Mating Force: 35N MAX
  - 2)Unmating Force: 10N MIN.
- 3.DIMENSIONS MARKED "▼" TO BE CHECKED BY Q.C & IPQC.

4.PART NO.

MUYF-05\*T-4BHUA684

1:Au 1U"  
6:Au 30U"

T:TIN  
N:NICKEL

W:WHITE  
B:BLACK

1:PBT  
2:PA6T  
3:PA9T  
4:LCP

Bill of materials:

3	SHELL	STAINLESS STEEL	1	PLATED TIN	X. ±0.35	X.' ±2'	UNITS	mm
2	HOUSING	LCP+30%GF	1	UL94V-0	.X ±0.30	.X' ±1'	MAT'L	SEE NOTE
1	TERMINAL	COPPER ALLOY	5	PLATED GOLD	.XX ±0.25	.XX'	FINISH	SEE NOTE
NO	PARTS	MATERIAL	QTY	FINISHING	.XXX ±0.15	.XXX'	Q'TY	SEE NOTE

THESE DRAWINGS AND SPECIFICATIONS ARE THE PROPERTY OF ACCURATE INDDTECH INC AND SHALL NOT BE REPRODUCED, COPIED OR USED IN ANY MANNER WITHOUT THE PRIOR WRITTEN CONSENT OF ACCURATE INDDTECH INC

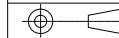

东莞市腾兴电子有限公司

TITLE:  
MICRO USB B TYPE F 5P 牛角型全插  
6.05 7.2有柱短针新模0.8版主体升级

DR: Ricky 2018/5/2

CHKD: Ricky 2018/5/2

APPD:

PART NO.:  
MUYF-05\*T-4BHUA684

DWG NO.:  
AII-HUA684

SCALE	SHEET	REV.	CUSTOMER DRAWING
5:1	1/1	A	