

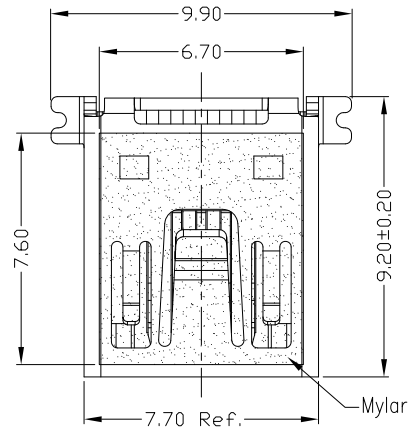

RoHS  
Compliant  
2002/95/EC

REV	LTR	DESCRIPTION	DATE	REVISER	APPD

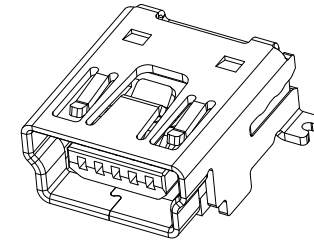
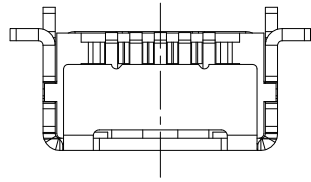

$\nabla$  0.10

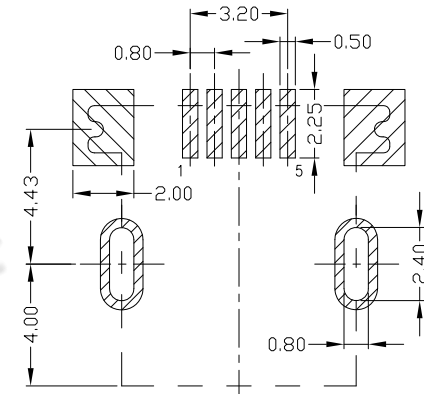
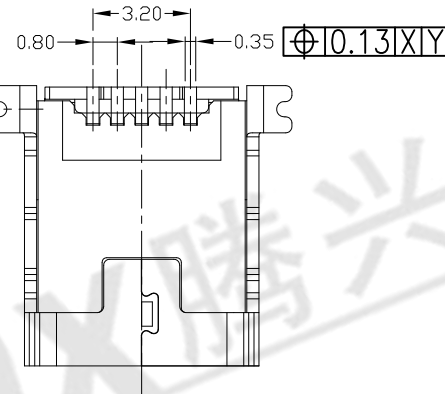
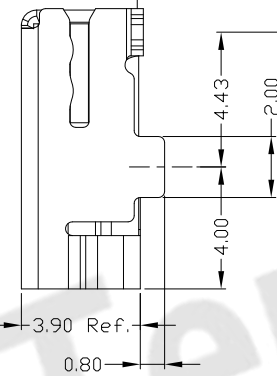

RECOMMENDED P.C.B LAYOUT

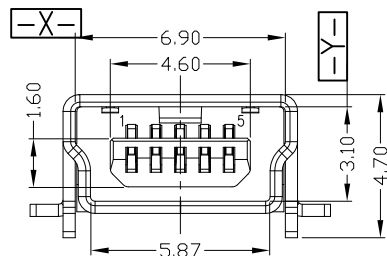

NOTES:

- ELECTRICAL:
  - VOLTAGE CURRENT RATING: 1.0AMP, 30V AC;
  - INSULATION RESISTANCE: 100MΩ MIN;
  - CONTACT RESISTANCE: 50mΩ MAX;
  - WITHSTANDING VOLTAGE: 300V AC;
  - OPERATING TEMPERATURE: -25°C TO +85°C.
- Mechanical:
  - Mating Force: 35N MAX
  - Unmating Force: 7N MIN.
- DIMENSIONS MARKED "▼" TO BE CHECKED BY Q.C & IPQC.

4. PART NO.

MUBF-05\*N-4BHUA151-M

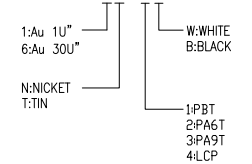

Bill of materials:

NO	PARTS	MATERIAL	QTY	FINISHING		UNITS	东莞市腾兴电子有限公司				
5					.X ±0.15	Ang1°	mm	TITLE: MINI USB 5P F SMT B Type 前插后贴无柱贴麦拉			
4					.XX ±0.10		MAT'L				
3	SHELL	COPPER ALLOY	1	PLATED NICKEL/TIN	.XXX ±0.05		SEE NOTE	DR: Ricky 2017/10/06			
2	HOUSING	LCP+30%GF	1	UL94V-0			FINISH				
1	TERMINAL	COPPER ALLOY	5	PLATED GOLD/TIN			SEE NOTE	CHKD: Ricky 2017/10/06			
							Q'TY				
								APPD:			