

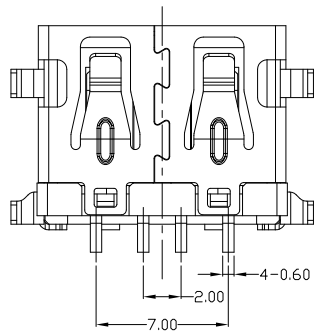

RoHS
Compliant
2002/95/EC

REV.	ECN.	NO.	APPD.

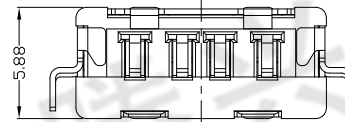
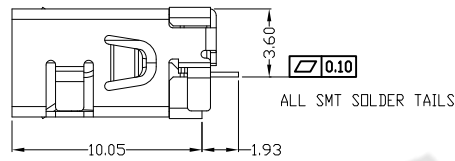
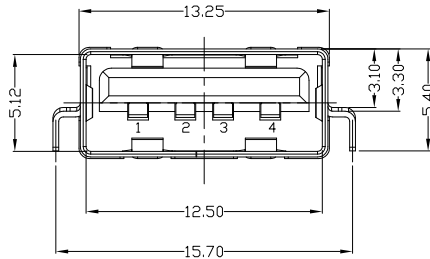
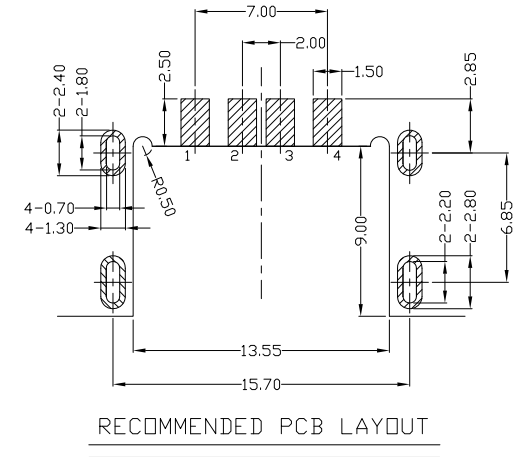
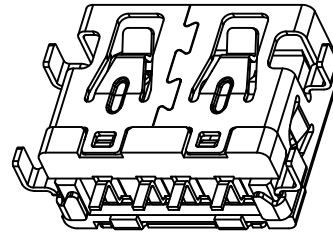
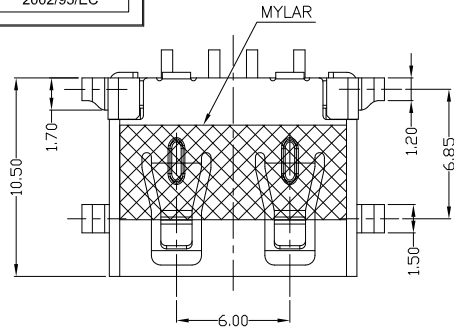

NOTES:

- ELECTRICAL:
 - VOLTAGE CURRENT RATING: 2AMP, 30V AC;
 - INSULATION RESISTANCE: 1000MΩ MIN;
 - CONTACT RESISTANCE: 30mΩ MAX;
 - WITHSTANDING VOLTAGE: 500V AC;
 - OPERATING TEMPERATURE: -25°C TO +85°C.
- Mechanical:
 - Mating Force: 35N MAX
 - Unmating Force: 10N MIN.
- NOTE: 1. DIMENSIONS MARKED "▼" TO BE CHECKED BY Q.C & IPQC.

4. PART NO.

USAF-041N-4BVS40

1: Au 1U*
5: Au 15u*
6: Au 30U*

W: WHITE
B: BLACK
G: GRAY

1: PBT
2: PA6T
3: PA9T
4: LCP

Bill of materials:

NO	PARTS	MATERIAL	QTY	FINISHING	X. ±0.35	X.* ±2*	UNITS	mm	东莞市腾兴电子有限公司					
3	HOUSING	LCP+30%GF	1	UL94V-0	.X ±0.3	.X* ±1*	MAT'L	SEE NOTE	TITLE: USB2.0 AF SMT 沉板 H3.6 带噪眼		PART NO.: USAF-041N-4BVS40			
2	SHELL	COPPER ALLOY	1	PLATED NICKEL	.XX ±0.25	.XX*	FINISH	SEE NOTE	DR: gan 2018/07/12		DWG NO.: AII-VS40			
1	TERMINAL	COPPER ALLOY	4	PLATED GOLD/TIN	.XXX ±0.15	.XXX*	Q'TY	SEE NOTE	CHKD: gan 2018/07/12		SCALE	SHEET	REV.	CUSTOMER
					THESE DRAWINGS AND SPECIFICATIONS ARE THE PROPERTY OF ACCURATE INNTECH INC AND SHALL NOT BE REPRODUCED, COPIED OR USED IN ANY MANNER WITHOUT THE PRIOR WRITTEN CONSENT OF ACCURATE INNTECH INC			APPD:		1:1	1/1	B	DRAWING	