

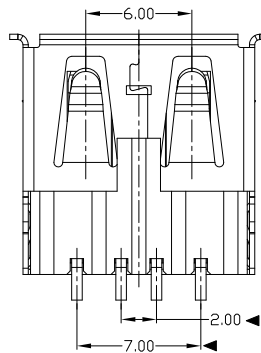

RoHS  
Compliant  
2002/95/EC

REV.	ECN. NO.	APPD.

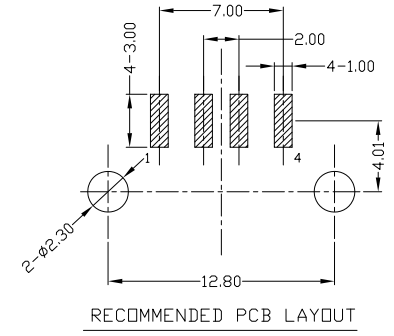
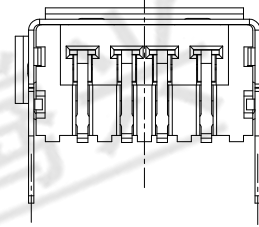
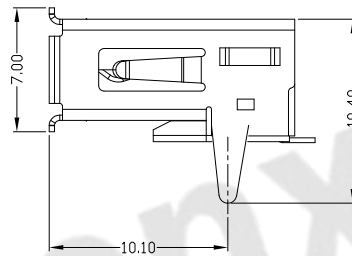
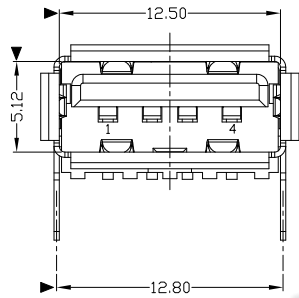
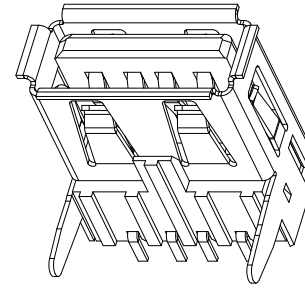
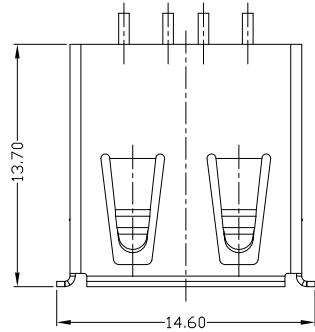

NOTES:

- ELECTRICAL:
  - VOLTAGE CURRENT RATING: 2AMP,30V AC;
  - INSULATION RESISTANCE: 1000MΩ MIN;
  - CONTACT RESISTANCE: 30mΩ MAX;
  - WITHSTANDING VOLTAGE: 500V AC;
  - OPERATING TEMPERATURE:-55°C TO +85°C.
- Mechanical:
  - Mating Force: 35N MAX
  - Unmating Force: 10N MIN.
- DIMENSIONS MARKED "▼" TO BE CHECKED BY Q.C & IPQC.

4.PART,NO.

USAF-04\*N-4\*V63

W:WHITE  
B:BLACK

1:Au 1U"  
6:Au 30U"

1:PBT  
2:PA6T  
3:PA9T  
4:LCP

Bill of materials:

NO	PARTS	MATERIAL	QTY	FINISHING	UNITS	mm	东莞市腾兴电子有限公司					
3	HOUSING	LCP	1	UL94V-0	X. ±0.35	X.' ±2'	SEE NOTE	TITLE:		PART NO.:		
2	SHELL	COPPER ALLOY	1	PLATED NICKEL	.X ±0.3	.X' ±1'		USB AF T型 直脚 SMT型		USAF-04*N-4*V63		
1	TERMINAL	COPPER ALLOY	4	PLATED GOLD/TIN	.XXX ±0.15	.XXX'		DR: Ricky 2014/04/10		DWG NO.: AII-V63		
THESE DRAWINGS AND SPECIFICATIONS ARE THE PROPERTY OF ACCURATE INNOVATECH INC AND SHALL NOT BE REPRODUCED, COPIED OR USED IN ANY MANNER WITHOUT THE PRIOR WRITTEN CONSENT OF ACCURATE INNOVATECH INC							Q'TY	CHKD: Ricky 2014/04/10	SCALE	SHEET	REV.	CUSTOMER DRAWING
								APPD:	1:1	1/1	B	