

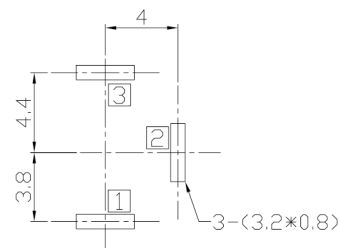

RoHS  
Compliant  
2002/95/EC

DIMENSIONS

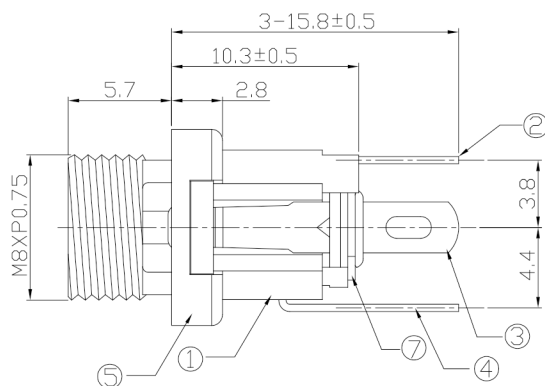
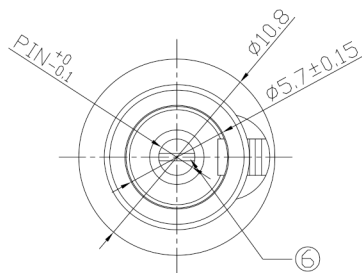

RECOMMENDED P.C.B. LAYOUT  
UNSPECIFIED TOLERANCE:±0.05  
(TOP VIEW)

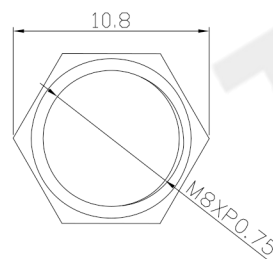
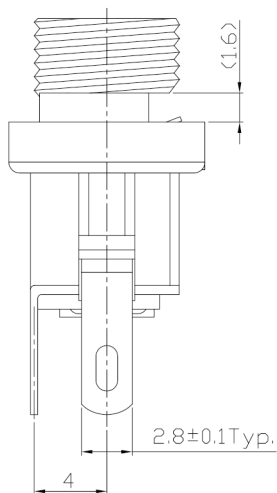

Nut

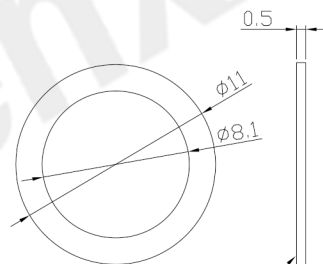

Washer

MODEL CODE:

DCB0-0025M- A □ PB BK C 0 4

(1) (2) (3)(4) (5) (6) (7)(8) (9)

(1):Series type:DIP DC POWER JACK.

(2):Series No.

(3):Schematic option: A , B

(4):Center pin diameter:

H=ø2.0 , I=ø2.35 , J=ø2.5

(5):Material of housing:

PB=PBT

(6):Housing color:

BK=Black

(7):Terminal plating

S=Silver(Ag)

T=Tin(Sn)

C=copper&tin alloy plating (Standard)

(8):Special option:

0=No special option

(9):Packing mode:

4=Bag packing

SPECIFICATION:

1.Rating : DC 30V 3A;

2.Contact resistance: ≤50mΩ

After test:≤50mΩ

3.Insulation resistance: ≥100MΩ (DC500V);

After test:≥50MΩ

4.Withstand voltage: 500VAC ;

5.Insertion and extraction force: 3-30N;

6.life test: 5,000 cycles;

7.Operation temperature range:-20°C~70°C;

8.Preservative temperature range:-40°C~85°C;

9.Torque standard of nut:12 N.m Max.

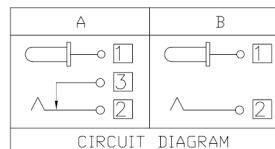

CIRCUIT DIAGRAM

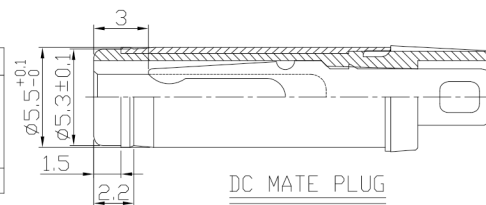

DC MATE PLUG

Model No.	H	I	J
CENTER PIN	ø2.0	ø2.35	ø2.5

○: ITEM NO. □: TERMINAL NO.

NO.	PARTS	MATERIAL	Q'TY	FINISHING
9	Washer-2	Spcc	1	Nickel plating
8	Nut	Brass	1	Nickel plating
7	Washer-1	Bakelite	2	
6	Pin	Bronze	1	Nickel plating
5	Bushing	Brass	1	Nickel plating
4	Shunt Terminal 3	Brass	1	Copper&tin plating
3	Tip Spring 2	Phosphor bronze	1	Copper&tin plating
2	Center pin terminal 1	Brass	1	Copper&tin plating
1	Housing	PBT	1	Black

THESE DRAWINGS AND SPECIFICATIONS ARE THE PROPERTY OF ACCURATE INNOVATECH INC AND SHALL NOT BE REPRODUCED, COPIED OR USED IN ANY MANNER WITHOUT THE PRIOR WRITTEN CONSENT OF ACCURATE INNOVATECH INC.

TOLERANCE	ANGLES	UNITS	mm
.X ±0.38	X ±5°	MAT'L	
.XX ±0.30	.X ±3°	SEE NOTE	
.XXX ±0.15	.XX ±2°	FINISH	
		SEE NOTE	
		Q'TY	

东莞市腾兴电子有限公司

TITLE:	DIP DC POWER JACK	PART NO.:	DCB0-0025M
DR:	Ricky 2019/04/10	DWG NO.:	AB0-0025M
CHKD:	Ricky 2019/04/10	SCALE	SHEET
APPD:		1:1	1/1
		REV.	A
		CUSTOMER DRAWING	