

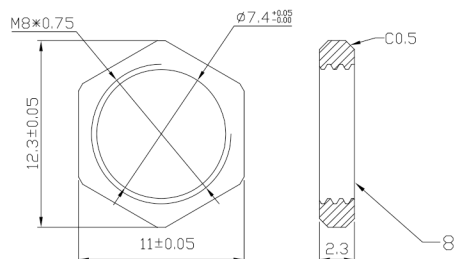

RoHS
Compliant
2002/95/EC

| REV. | ECN. | NO. | APPD. |
|------|------|-----|-------|
| | | | |
| | | | |

DIMENSIONS

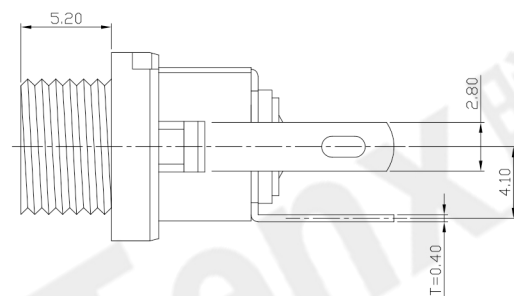
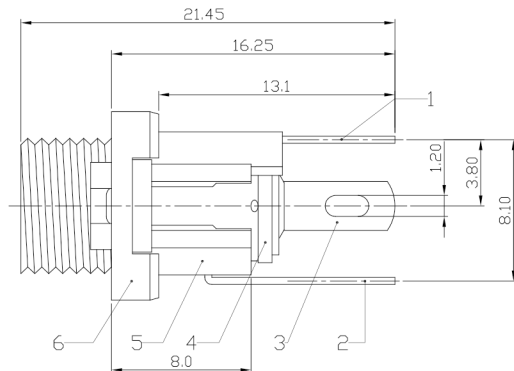
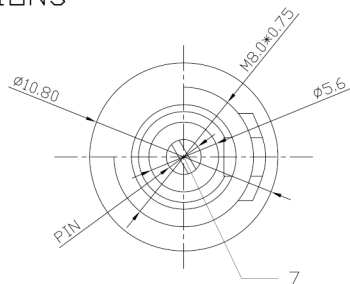

Nut

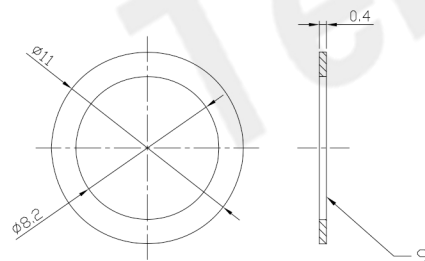

Washer

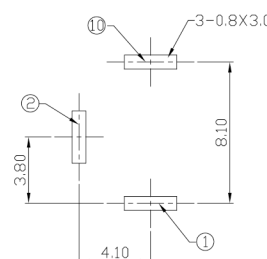

P.C.B LAYOUT

MODEL CODE:
DCE0-00260- A □ P□ BK S 0 4
(1) (2) (3)(4) (5) (6) (7)(8) (9)
(1):Series type:DIP DC POWER JACK.
(2):Series No.
(3):Schematic option: A
(4):Center pin diameter:
H=φ2.0 , I=φ2.35 , J=φ2.5
(5):Material of housing:
P□=POM
(6):Housing color:
BK=Black
(7):Terminal plating
S=Silver(Ag)
(8):Special option:
0=No special option
(9):Packing mode:
4=Bag packing

Specification:
1.Rating :DC 30V 0.3A.
2.Contact resistance :≤100mΩ
3.Insulation resistance :≥100MΩ (500VDC).
4.Withstanding voltage: 500VAC .
5.Insertion and extraction force: 0.3~3Kgs.
6.life test: 5000cycles min.
7.Operation temperature range:-25°C~85°C

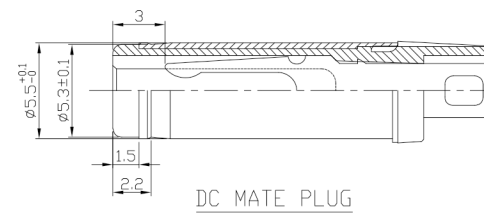
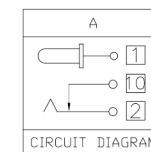

DC MATE PLUG

| Model No. | H | I | J |
|------------|------|-------|------|
| CENTER PIN | φ2.0 | φ2.35 | φ2.5 |

Bill of materials:

| NO. | PARTS | MATERIAL | Q'TY | FINISHING |
|-----|-----------------|-------------|------|-----------|
| 9 | WASHER-2 | SPCC | 1 | Ni PLATED |
| 8 | NUT | BRASS | 1 | Ni PLATED |
| 7 | PLUG PIN | BRASS | 1 | Ni PLATED |
| 6 | SOCKET | BRASS | 1 | Ni PLATED |
| 5 | CASE | POM | 1 | BLACK |
| 4 | WASHER-1 | PAPER TAPE | 2 | RED |
| 3 | SPRING TERMINAL | PBS STRIP | 1 | Ag PLATED |
| 2 | CONTACT | BRASS STRIP | 1 | Ag PLATED |
| 1 | TERMINAL | BRASS STRIP | 1 | Ag PLATED |

GENERAL TOLERANCE
UNITS mm
WITHIN 1.5mm±0.1mm
MAT'L
OVER 1.5mm±0.2mm
SEE NOTE
FINISH
SEE NOTE
Q'TY

THESE DRAWINGS AND SPECIFICATIONS ARE THE PROPERTY OF ACCURATE INNO TECH INC AND SHALL NOT BE REPRODUCED, COPIED OR USED IN ANY MANNER WITHOUT THE PRIOR WRITTEN CONSENT OF ACCURATE INNO TECH INC.

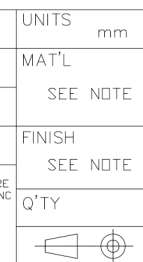

东莞市腾兴电子有限公司

| | |
|-----------------------------|-----------------------------------|
| TITLE: DIP DC POWER JACK | PART NO.: DCE0-00260 |
| DR: Ricky 2019/03/18 | DWG NO.: AZJ-00260 |
| CHKD: Ricky 2019/03/18 | SCALE SHEET REV. CUSTOMER DRAWING |
| APPD: | 1:1 1/1 A |