

1A Series

Sealed Miniature Toggle Switches

1A
Toggle Switches

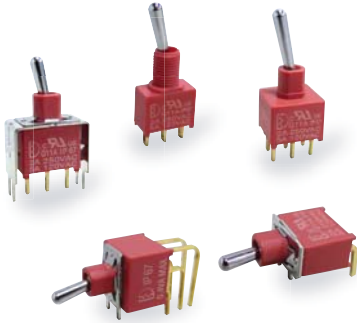

IP 67
ACCORDING TO
EN 60529:1991+A1:2001
IEC 60029:2001

CUL
E 187490

RoHS
compliant

Pb
lead-free

SPECIFICATIONS

CONTACT RATING: Dependent upon contact material See page 17.

MECHANICAL LIFE: 30,000 make-and-break cycles.

CONTACT RESISTANCE: 10 mΩ max. initial @ 2-4VDC
100mA for both silver and gold plated contacts.

INSULATION RESISTANCE: 1,000 MΩ min.

DIELECTRIC STRENGTH: 1,000 Vrms min. @sea level.

OPERATING TEMPERATURE: -40°C to 85°C.

MATERIALS

CASE & BUSHING: Glass filled nylon 6/6, flame retardant, heat stabilized (UL94v-0).

ACTUATOR: Brass, chrome plated with internal, O-ring seal standard.

SWITCH SUPPORT: Brass or steel, tin plated.

SWITCH SUPPORT RETAINER: Stainless steel.

CONTACT / TERMINALS: Copper alloy, with Silver or gold plated.
(See Page 17)

HOW TO ORDER

MODEL NO. ACTUATOR BUSHING TERMINATIONS TERMINAL PLATING SEAL RoHS SOLDERING

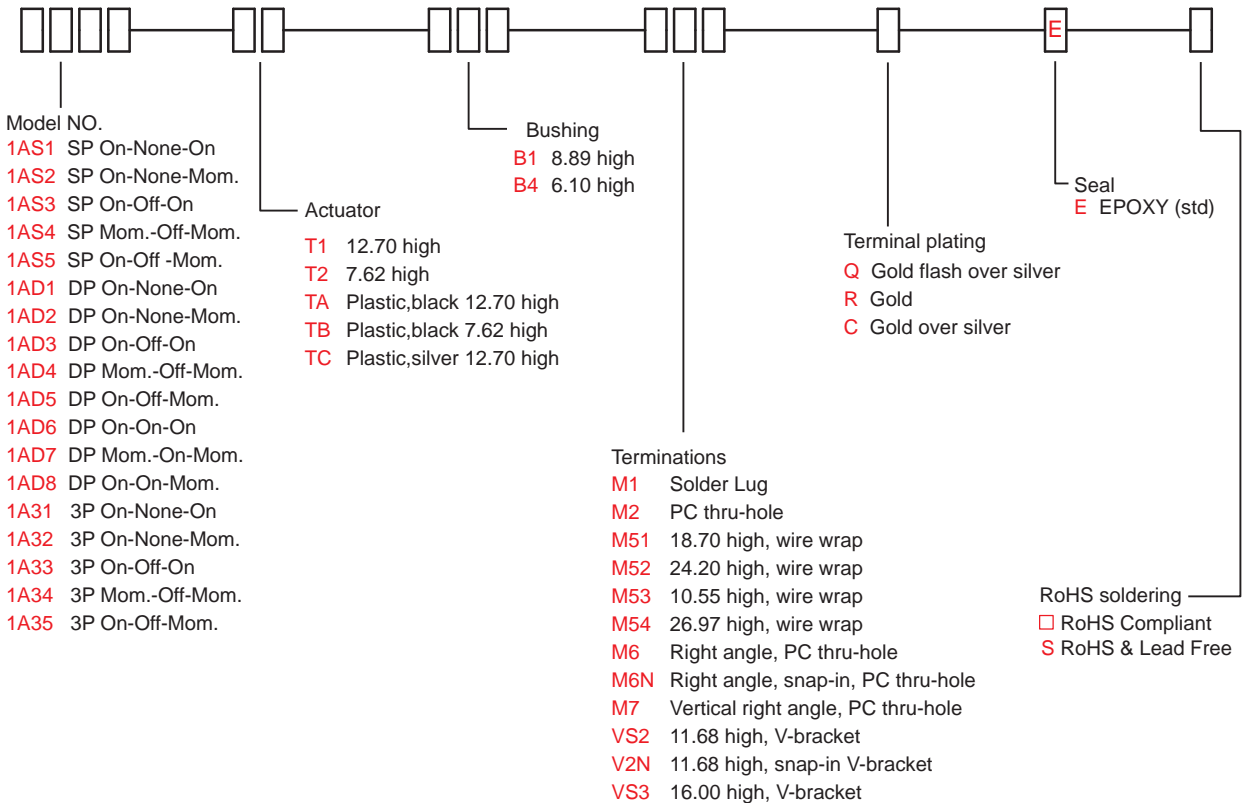

SWITCH FUNCTION

NO. POLES	UL/CSA MODEL NO.	MODEL NO.	SWITCH FUNCTION			CONNECTED TERMINALS / SCHEMATIC		
			POS.1	POS.2	POS.3	POS.1	POS.2	POS.3
SP	Q11A11	1AS1	ON	NONE	ON			
	Q11A12	1AS2	ON	NONE	MOM			
	Q11A13	1AS3	ON	OFF	ON			
	Q11A14	1AS4	MOM	OFF	MOM			
	Q11A15	1AS5	ON	OFF	MOM			
DP	Q11A21	1AD1	ON	NONE	ON			
	Q11A22	1AD2	ON	NONE	MOM			
	Q11A23	1AD3	ON	OFF	ON			
	Q11A24	1AD4	MOM	OFF	MOM			
	Q11A25	1AD5	ON	OFF	MOM			
	▲ Q11A27	1AD7	MOM	ON	MOM			
	▲ Q11A28	1AD8	ON	ON	MOM			
	3P	Q11A31	1A31	ON	NONE		ON	
Q11A32		1A32	ON	NONE	MOM			
Q11A33		1A33	ON	OFF	ON			
Q11A34		1A34	MOM	OFF	MOM			
Q11A35		1A35	ON	OFF	MOM			

MOM=MOMENTARY

▲ Please check the availability in advance before order

POLE OPTIONS

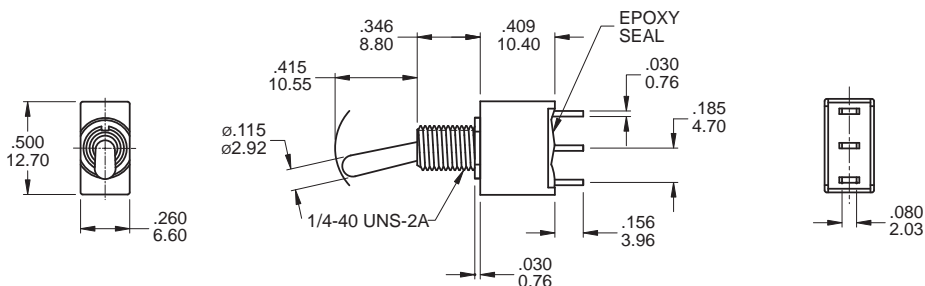

SPDT

Part No. Shown : 1AS1T1B1M1QE



1A
Toggle Switches

1A Series

Sealed Miniature Toggle Switches

1A
Toggle Switches

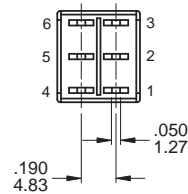
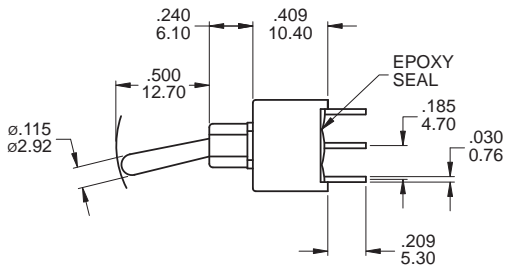
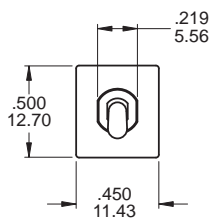

DPDT

Part No. Shown : 1AD1T1B4M2QE

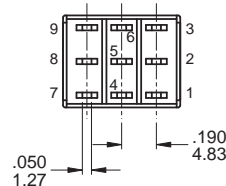
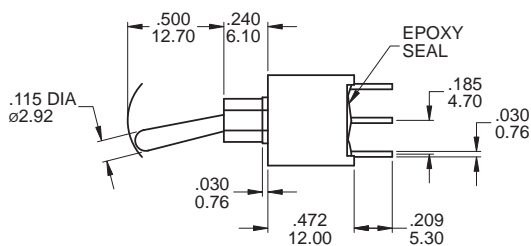
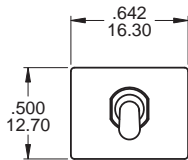

3PDT

Part No. Shown : 1A31T1B4M2QE

ACTUATOR OPTIONS

Actuator shown with standard B4 Bushing,
Subtract .085 (2.15) for B1 bushing.

T1

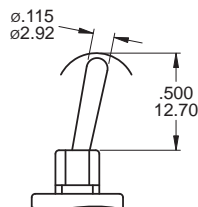

Standard with
M1, M2 terminations.

T2

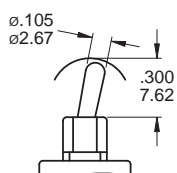

Standard with
M6, M7, VS2-3 terminations.

TA

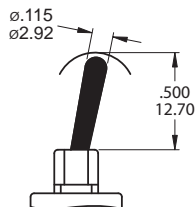

TB

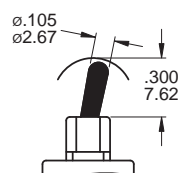

PLASTIC ACTUATOR
(TC, Silver)

BUSHING OPTIONS

B1

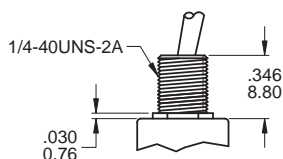

Std for M1

B4

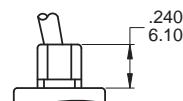

Std for M2, M6, M7, VS termination

TERMINATION OPTIONS

M1 Solder lug

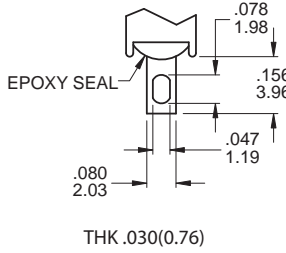

M2 PC Thru-hole

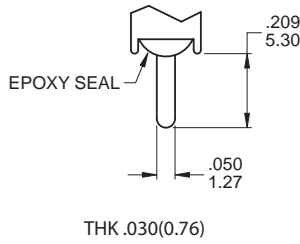

M3 Quick connect

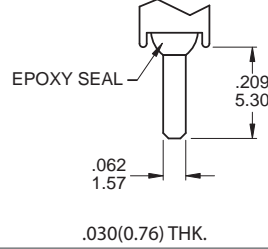

M5 Wire Wrap

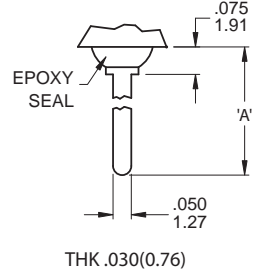

OTHER TERMINATION OPTIONS

M6 Right angle P.C. Mount

M7 Vertical right angle P.C. Mount

VS2 Vertical bracket P.C. Mount

VS3 Vertical bracket P.C. Mount

M6N Right angle P.C. Mount with snap-in bracket

V2N Vertical bracket P.C. Mount with snap-in bracket

OPTION CODE	DIM. 'A'
M51	.736 (18.70)
M52	.953 (24.20)
M53	.415 (10.55)
M54	1.062 (26.97)

M6

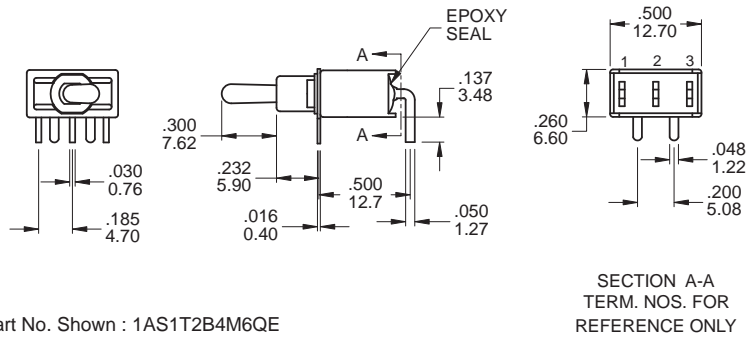

P.C. MOUNTING

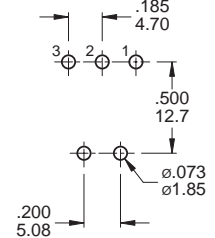

SPDT

Part No. Shown : 1AS1T2B4M6QE

M6

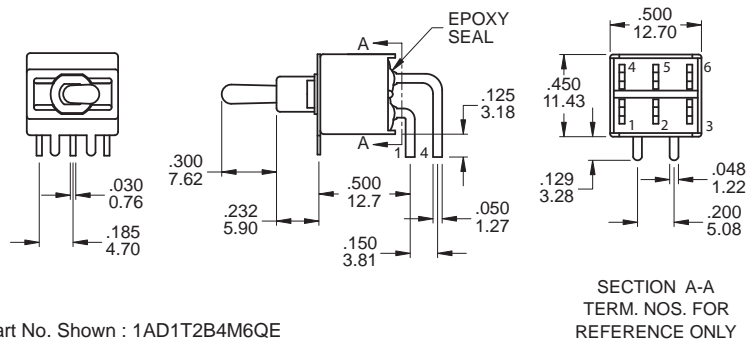

P.C. MOUNTING

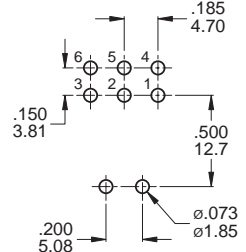

DPDT

Part No. Shown : 1AD1T2B4M6QE

M7

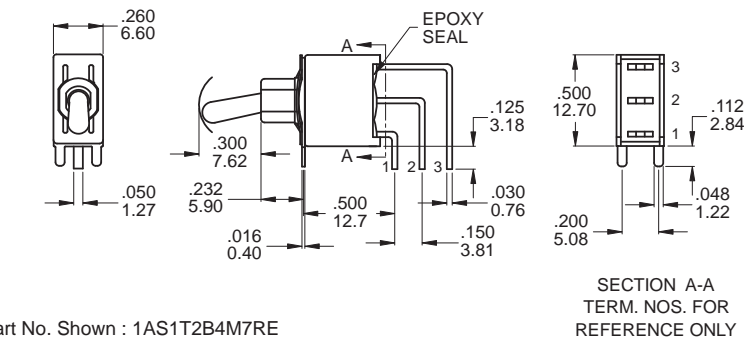

P.C. MOUNTING

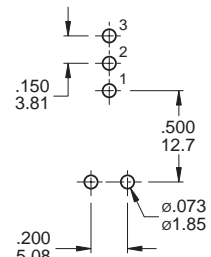

SPDT

Part No. Shown : 1AS1T2B4M7RE



1A
Toggle Switches

1A Series

Sealed Miniature Toggle Switches

1A
Toggle Switches

M7

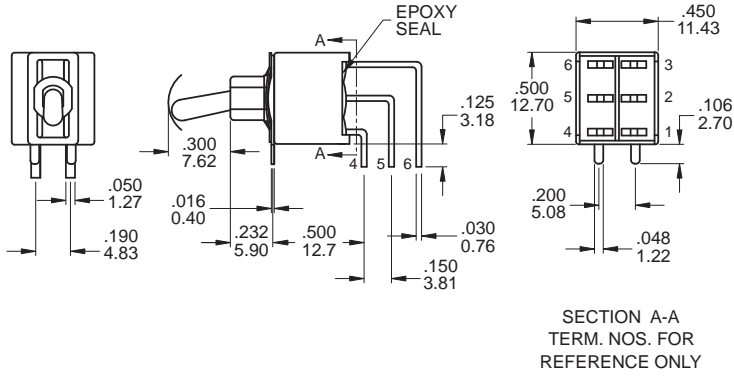
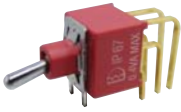

P.C. MOUNTING

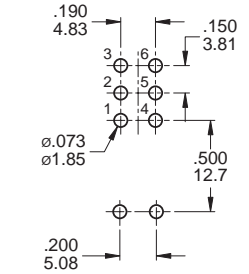

DPDT

Part No. Shown : 1AD1T2B4M7RE

M7

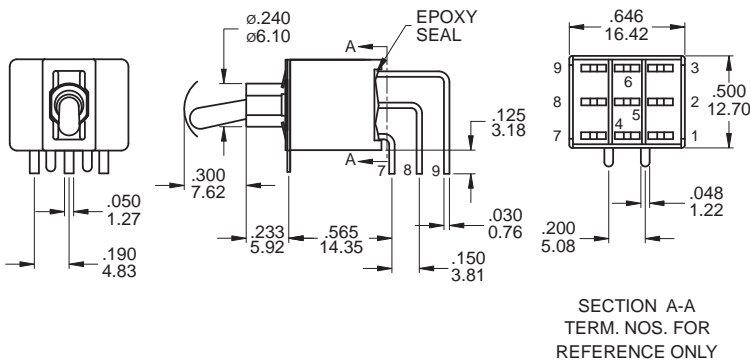

P.C. MOUNTING

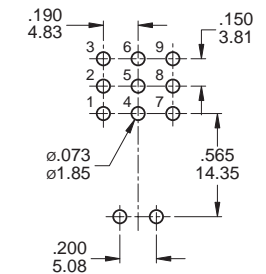

3PDT

Part No. Shown : 1A31T2B4M7QE

VS2 - VS3

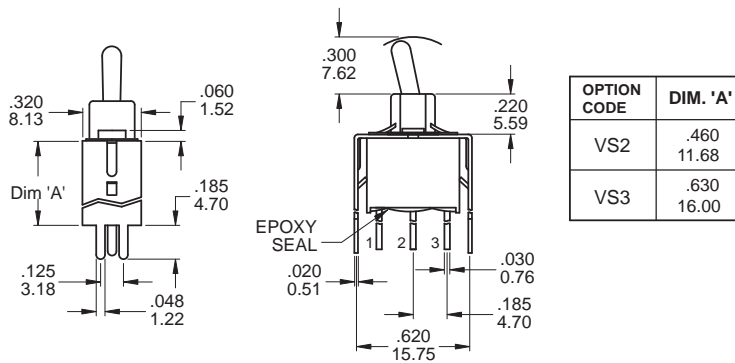

P.C. MOUNTING

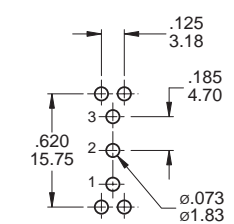

SPDT

Part No. Shown : 1AS1T2B4VS2QE

VS2 - VS3

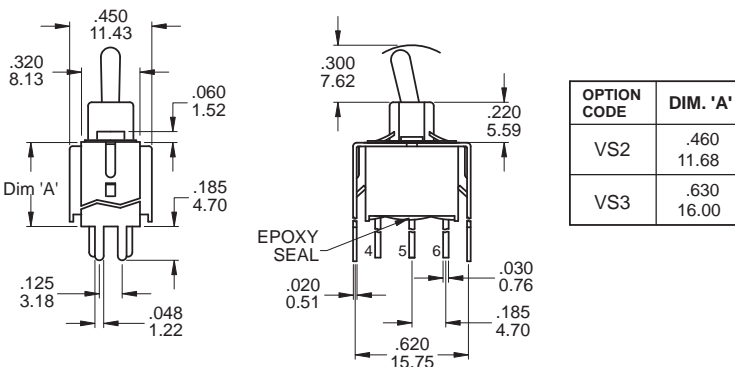

P.C. MOUNTING

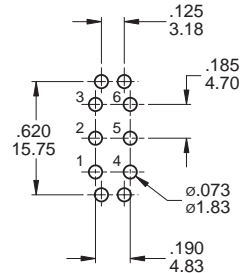

DPDT

Part No. Shown : 1AD1T2B4VS2QE

VS2 - VS3

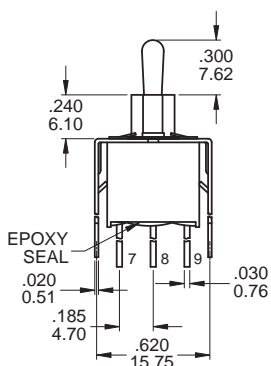
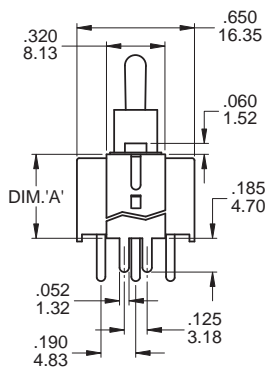

OPTION CODE	DIM. 'A'
VS2	.460 11.68
VS3	.630 16.00

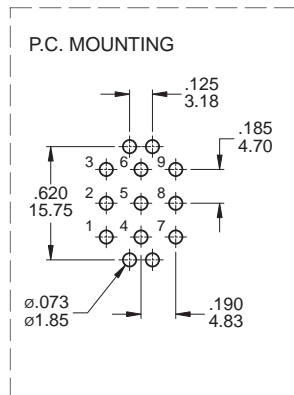

3PDT

Part No. Shown : 1A31T2B4VS2QE

SNAP-IN TERMINATION OPTIONS

M6N

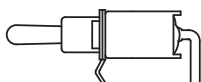

V2N

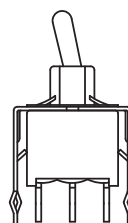

HARDWARE

1/4 NUT

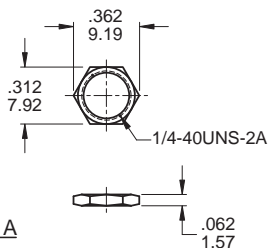

MNU-1M01A

LOCKING RING

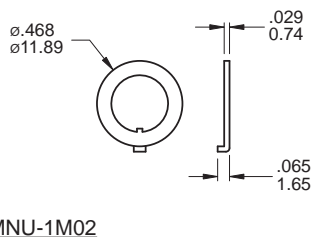

MNU-1M02

LOCKWASHER

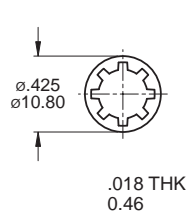

MNU-1M03

CONTACT MATERIAL OPTIONS

	CONTACT PLATING	TERMINAL PLATING	RATINGS
Q	Silver	Q = Gold flash over silver	5 Amps with resistant load @ 120VAC or 28VDC 2 Amps with resistant load @ 250VAC
C	Gold over Silver	C = Gold over silver	
R	Gold	R = Gold	0.4 Volt - Amps (VA) max. @ 20V max. (AC or DC)

SOLDERING PROCESSES

MANUAL SOLDERING: Use soldering iron of 30 watts, controlled at 350°C approximately 5 seconds while applying solder.

WAVE SOLDERING: Recommended Soldering Temperature: 270 ± 5°C

Duration of Solder Immersion: Max 5 sec. (PCB is 1.6mm in thickness)



1A
Toggle Switches

1A Series

Sealed Toggle Switches

SPECIFICATIONS

CONTACT RATING: 0.4Volt-Amps(VA) max. @20V max(AC or DC)

MECHANICAL LIFE: 100,000 make-and-break cycles.

ELECTRICAL LIFE: 50,000 cycles.

CONTACT RESISTANCE: 10 mΩ max. initial @ 2-4VDC
100mA for both silver and gold plated contacts.

INSULATION RESISTANCE: 1,000 MΩ min.

DIELECTRIC STRENGTH: 1,000 V RMS@sea level.

OPERATING TEMPERATURE: -30°C to 85°C.

GENERAL SPECIFICATIONS

TORQUE: 0.8Nm max. applied to unt.

PANEL THICKNESS: 6mm max. ,2mm min.

MATERIALS

CASE & BUSHING: Glass filled nylon 6/6, flame retardant, heat stabilized (UL94v-0).

ACTUATOR: Brass, chrome plated with internal, O-ring seal standard.

SWITCH SUPPORT: Brass or steel, tin plated.

CONTACT / TERMINALS: Copper alloy, gold plated.

SEALIND: IP67.

IP 67
ACCORDING TO
EN 60529 1991+A1:2001
IEC 60529:2001



SWITCH FUNCTION

NO. POLES	MODEL NO.	SWITCH FUNCTION			CONNECTED TERMINALS / SCHEMATIC		
		POS.1	POS.2	POS.3	POS.1	POS.2	POS.3
SP	1AS1	ON	NONE	ON	2-3 	N/A	2-1
	1AS2	ON	NONE	MOM		OPEN 	
	1AS3	ON	OFF	ON			
	1AS4	MOM	OFF	MOM			
	1AS5	ON	OFF	MOM			
	1AS9	ON	NONE	OFF	2-3	N/A	OPEN
	1ASD	MOM	NONE	OFF			

MOM=MOMENTARY

M1

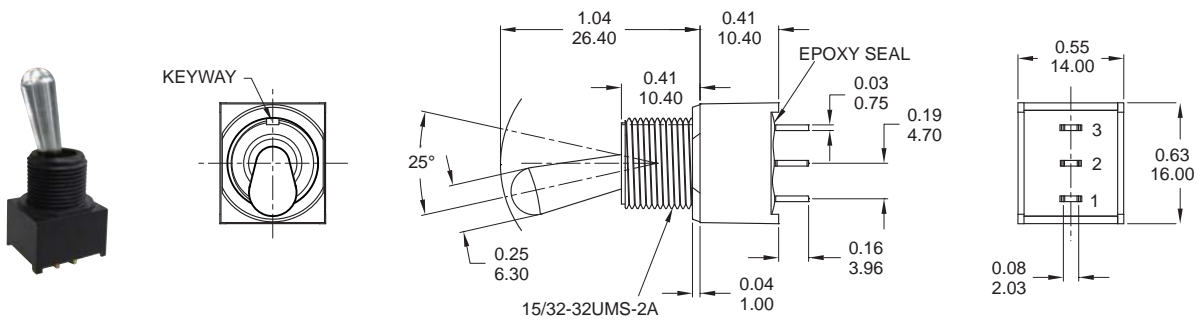

Part No. Shown : 1AS1T8B22M1RPES

PANEL MOUNTING / HARDWARE

PANEL MOUNTING

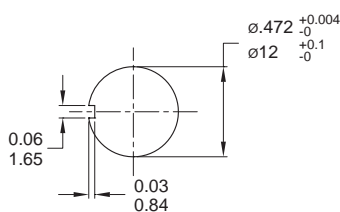

NUT

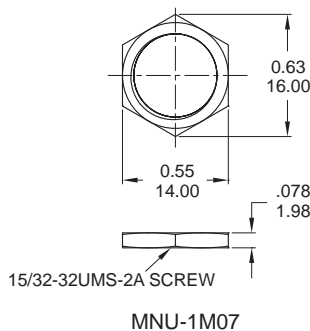

SEALING BOOTS

