



RoHS
Compliant
2002/95/EC

REV.	ECN. NO.	APPD.

MODEL CODE

SS-22H07-GEE

Knob Type
GEE
VAC

L(mm)
~

DIMENSIONS

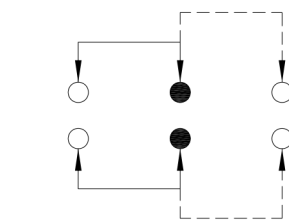
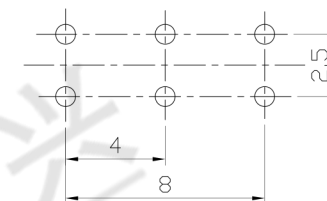
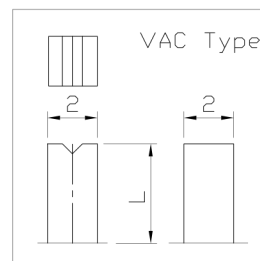
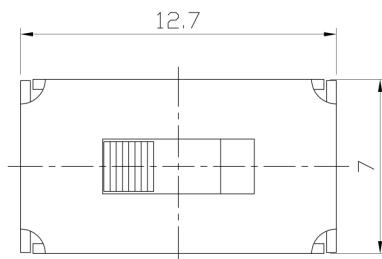

P.C.B LAYOUT
BOTTOM VIEW

CIRCUIT DIAGRAM

ELECTRO-MECHANICAL CHARACTERISTICS

Refer to additional specifications

RATING	0.3A 50V DC
CIRCUIT	2P2T
CONTACT RESISTANCE	100mΩ MAX.
TIMING	NON-SHORTING
TRAVEL	4mm
OPERATING FORCE	250±100gf
OPERATING LIFE(cycles)	10,000

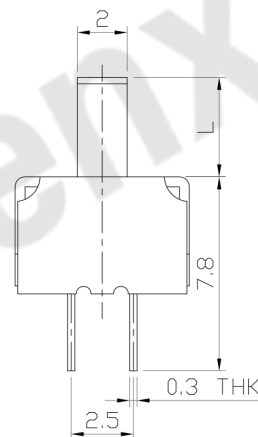
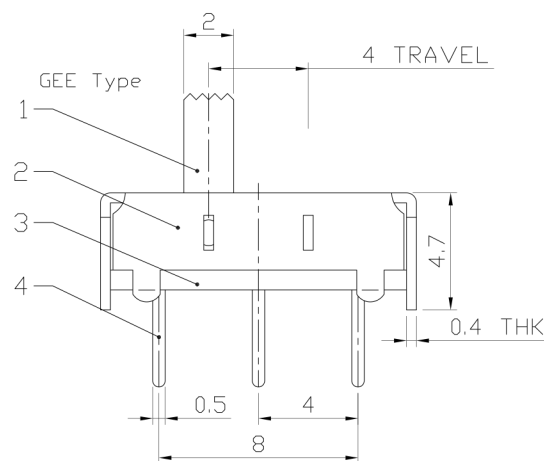

8					WITHIN 1.5mm: ±0.1mm	UNITS	mm
7					OVER 1.5mm: ±0.2mm	MAT'L	
6	SPRING PLATED	PBS STRIP	1	NATURAL		SEE NOTE	
5	CONTACT CLIP	PBS STRIP	2	Ag PLATED			
4	TERMINAL	BRASS STRIP	6	Ag PLATED		FINISH	
3	BASE	PHENOLIC RESIN	1	NATURAL		SEE NOTE	
2	FRAME	STEEL STRIP	1	Ni PLATED		Q'TY	
1	KNOB	POM	1	BLACK			
NO.	PARTS	MATERIAL	Q'TY	FINISHING			

THESE DRAWINGS AND SPECIFICATIONS ARE THE PROPERTY OF ACCURATE INNOVATION INC AND SHALL NOT BE REPRODUCED, COPIED OR USED IN ANY MANNER WITHOUT THE PRIOR WRITTEN CONSENT OF ACCURATE INNOVATION INC.

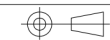

东莞市腾兴电子有限公司

TITLE:	SLIDE SWITCH / VERTICAL	PART NO.:	SS-22H07
DR:	Ricky 2015/05/28	DWG NO.:	ADL-22H07
CHKD:	Ricky 2015/05/28	SCALE	7:2
APPD:		SHEET	1/1
		REV.	A
		CUSTOMER DRAWING	