

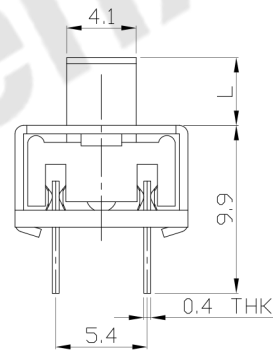

RoHS Compliant
2002/95/EC

REV.	ECN.	NO.	APPD.

DIMENSIONS

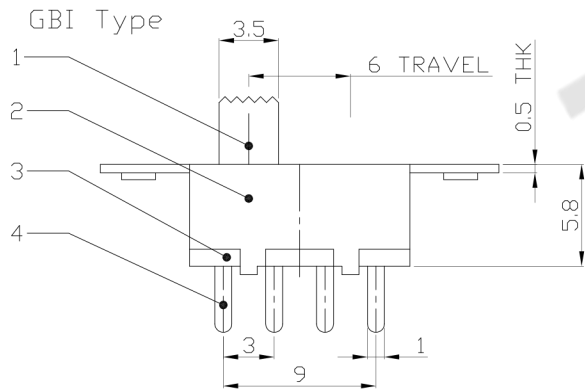
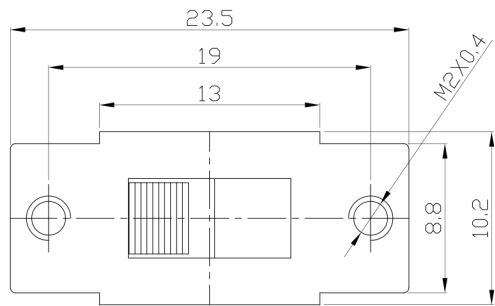

MODEL CODE

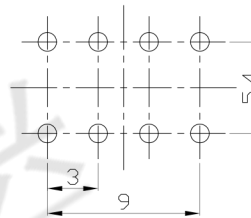
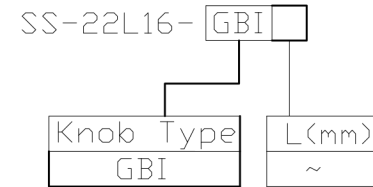

P.C.B LAYOUT
BOTTOM VIEW

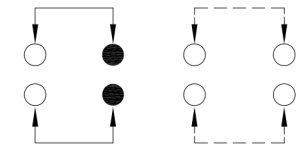

CIRCUIT DIAGRAM

ELECTRO-MECHANICAL CHARACTERISTICS

Refer to additional specifications

RATING	0.3A 50V DC
CIRCUIT	2P2T
CONTACT RESISTANCE	100mΩ MAX.
TIMING	SHORTING
TRAVEL	6mm
OPERATING FORCE	250±100gf
OPERATING LIFE(cycles)	10,000

8					WITHIN 1.5mm: ±0.1mm	UNITS	mm
7	STEEL BALL	STEEL	1	NATURAL	OVER 1.5mm: ±0.2mm	MAT'L	
6	SPRING	STEEL WIRE	1	NATURAL		SEE NOTE	
5	CONTACT CLIP	PBS STRIP	2	Ag PLATED		FINISH	
4	TERMINAL	BRASS STRIP	8	Ag PLATED		SEE NOTE	
3	BASE	PHENOLIC RESIN	1	NATURAL		Q'TY	
2	FRAME	STEEL STRIP	1	Ni PLATED			
1	NOB	POM	1	BLACK			
NO.	PARTS	MATERIAL	Q'TY	FINISHING			

THESE DRAWINGS AND SPECIFICATIONS ARE THE PROPERTY OF ACCURATE INNO TECH INC AND SHALL NOT BE REPRODUCED, COPIED OR USED IN ANY MANNER WITHOUT THE PRIOR WRITTEN CONSENT OF ACCURATE INNO TECH INC.

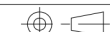

东莞市腾兴电子有限公司

TITLE:	SLIDE SWITCH / VERTICAL	PART NO.:	SS-22L16
DR:	Ricky 2015/09/04	DWG NO.:	ADL-22L16
CHKD:	Ricky 2015/09/04	SCALE	3:1
APPD:		SHEET	1/1
		REV.	A
		CUSTOMER DRAWING	