

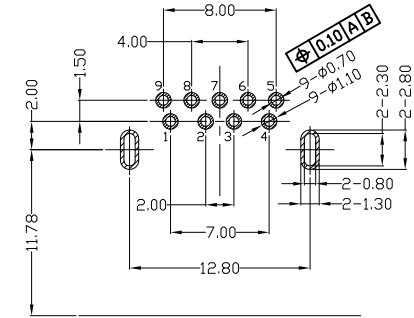

RoHS
Compliant
2002/95/EC

Halogen Free

REV.	ECN.	NO.	APPD.

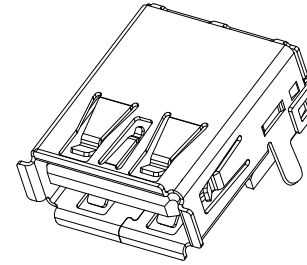
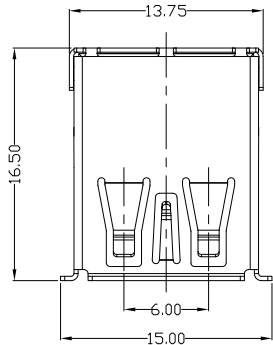

CONN FRONT EDGE

RECOMMENDED P.C.B LAYOUT(±0.05)

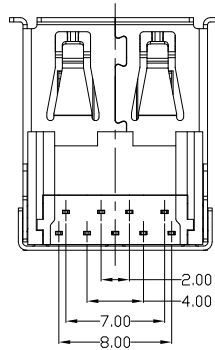
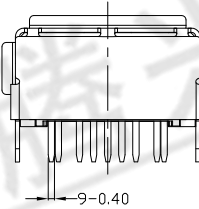
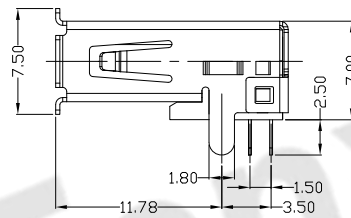
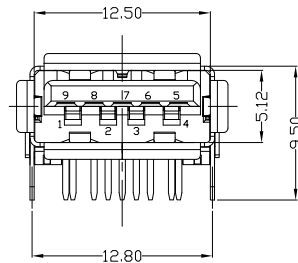

NOTES:

- ELECTRICAL:
 - VOLTAGE CURRENT RATING:1.5AMP,30V AC;
 - INSULATION RESISTANCE: 1000Ω MIN;
 - CONTACT RESISTANCE: 30mΩ MAX;
 - WITHSTANDING VOLTAGE: 500V AC;
 - OPERATING TEMPERATURE:-55°C TO +105°C.
- Mechanical:
 - Mating Force: 35N MAX
 - Unmating Force: 10N MIN.
- NOTE:1.DIMENSIONS MARKED "▼" TO BE CHECKED BY Q.C & IPQC.

4.PART NO.

USAF-091N-4BLRS46-H

1:Au 1U"
5:Au 15u"
6:Au 30U"

1:PBT
2:PA6T
3:PA9T
4:LCP

W:WHITE
B:BLACK
BL:BLUE

Bill of materials:

NO	PARTS	MATERIAL	QTY	FINISHING	X.	X.* ±2*	UNITS
5	HOUSING	LCP+30%GF HF (Halogen Free)	1	UL94V-0	X. ±0.35	X.* ±2*	mm
4	COVER	LCP+30%GF HF (Halogen Free)	1	UL94V-0	.X ±0.3	.X* ±1*	MAT'L
3	SHELL	COPPER ALLOY	1	PLATED NICKEL	.XX ±0.25	.XX*	SEE NOTE
2	TERMINAL(4P)	COPPER ALLOY	4	PLATED GOLD/TIN	.XXX ±0.15	.XXX*	FINISH
1	TERMINAL(5P)	COPPER ALLOY	5	PLATED GOLD/TIN			SEE NOTE
							Q'TY

THESE DRAWINGS AND SPECIFICATIONS ARE THE PROPERTY OF ACCURATE INNO TECH INC AND SHALL NOT BE REPRODUCED, COPIED OR USED IN ANY MANNER WITHOUT THE PRIOR WRITTEN CONSENT OF ACCURATE INNO TECH INC



东莞市腾兴电子有限公司

TITLE:
USB 3.0 AF 90度 DIP 脚距12.80 卷边 蓝胶 无卤

DR: gan 2018/07/12

CHKD: gan 2018/07/12

APPD:

PART NO.:
USAF-091N-4BLRS46-H

DWG NO.:
AII-RS46-H

SCALE: 1:1

SHEET: 1/1

REV.: B

CUSTOMER DRAWING