

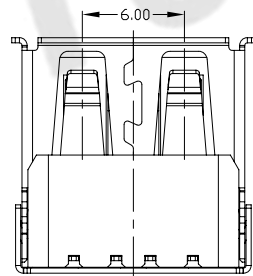

RoHS
Compliant
2002/95/EC

REV.	ECN.	NO.	APPD.

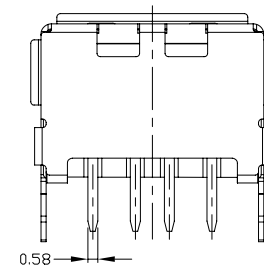
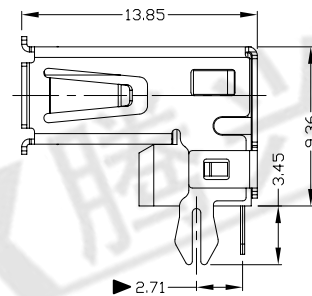
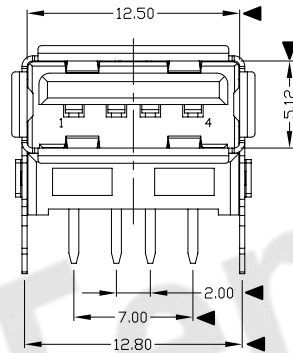
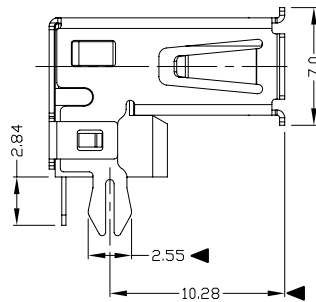
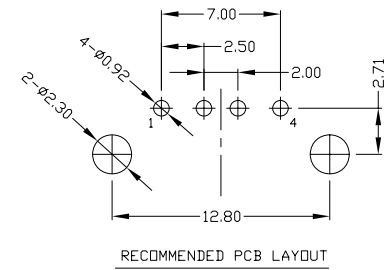
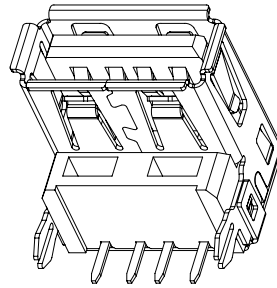
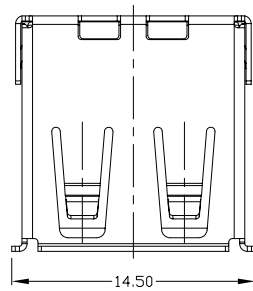

NOTES:

- ELECTRICAL:
 - VOLTAGE CURRENT RATING: 2AMP, 30V AC;
 - INSULATION RESISTANCE: 1000MΩ MIN;
 - CONTACT RESISTANCE: 30mΩ MAX;
 - WITHSTANDING VOLTAGE: 500V AC;
 - OPERATING TEMPERATURE: -55°C TO +85°C.
- Mechanical:
 - Mating Force: 35N MAX
 - Unmating Force: 10N MIN.
- NOTE: 1. DIMENSIONS MARKED "▼" TO BE CHECKED BY Q.C & IPQC.

4. PART NO.

USAF-04*N-1*R67

1: Au 1U*
6: Au 30U*

W: WHITE
B: BLACK

1: PBT
2: PA6T
3: PA9T
4: LCP

Bill of materials:

NO	PARTS	MATERIAL	QTY	FINISHING	UNITS	mm	东莞市腾兴电子有限公司						
3	HOUSING	PBT+30%GF	1	UL94V-0	X. ±0.35	X.* ±2*	SEE NOTE	TITLE: USB A/F 90° DIP 加高型		PART NO.: USAF-04*N-1*R67			
2	SHELL	COPPER ALLOY	1	PLATED NICKEL	.X ±0.3	.X* ±1*		DR: Ricky 2014/04/10	DWG NO.: AII-R67				
1	TERMINAL	COPPER ALLOY	4	PLATED GOLD/TIN	.XXX ±0.15	.XXX*	FINISH	CHKD: Ricky 2014/04/10		SCALE	SHEET	REV.	CUSTOMER
					THESE DRAWINGS AND SPECIFICATIONS ARE THE PROPERTY OF ACCURATE INNOTECH INC AND SHALL NOT BE REPRODUCED, COPIED OR USED IN ANY MANNER WITHOUT THE PRIOR WRITTEN CONSENT OF ACCURATE INNOTECH INC.		Q'TY	APPD:	1:1	1/1	B	DRAWING	