

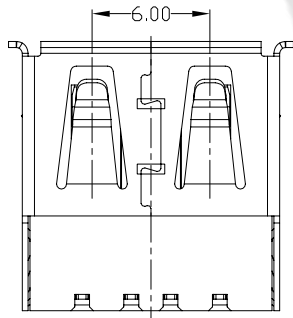

RoHS
Compliant
2002/95/EC

REV.	ECN.	NO.	APPD.

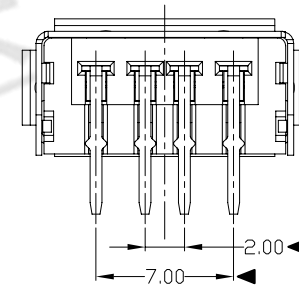
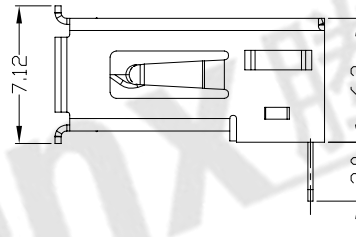
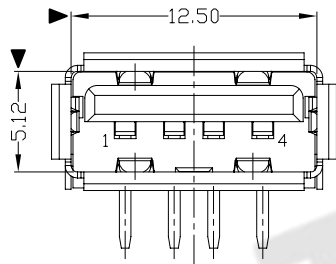
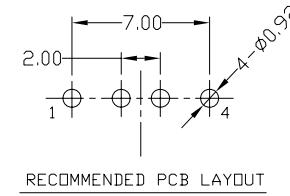
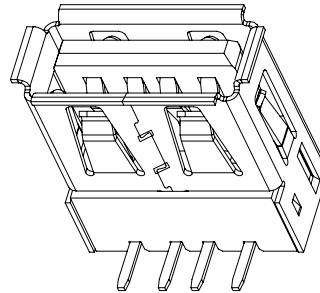
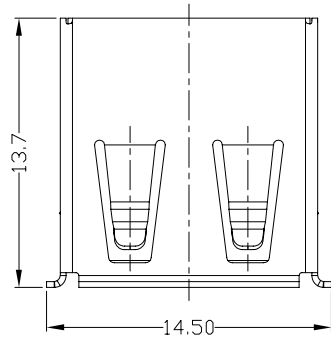

NOTES:

- ELECTRICAL:
 - VOLTAGE CURRENT RATING: 2AMP, 30V AC;
 - INSULATION RESISTANCE: 1000MΩ, MIN;
 - CONTACT RESISTANCE: 30mΩ MAX;
 - WITHSTANDING VOLTAGE: 500V AC;
 - OPERATING TEMPERATURE: -55°C TO +85°C.
- Mechanical:
 - Mating Force: 35N MAX.
 - Unmating Force: 10N MIN.
- NOTE: 1. DIMENSIONS MARKED '▼' TO BE CHECKED BY Q.C & IPQC.

4. PART NO.

USAF-04*N-1*R610

1: Au 1U*
6: Au 30U*

W: WHITE
B: BLACK

1: PBT
2: PA6T
3: PA9T
4: LCP

Bill of materials:

NO	PARTS	MATERIAL	QTY	FINISHING	UNITS	mm	东莞市腾兴电子有限公司						
3	HOUSING	PBT	1	UL94V-0	X. ±0.35	X.' ±2'	MAT'L	TITLE: USB AF DIP90度一型无脚无后盖		PART NO.: USAF-04*N-1*R610			
2	SHELL	COPPER ALLOY	1	PLATED NICKEL	.XX ±0.25	.XX'						SEE NOTE	
1	TERMINAL	COPPER ALLOY	4	PLATED GOLD/TIN	.XXX ±0.15	.XXX'	FINISH	DR: gan 2012/6/29		DWG NO.: AII-R610			
NO	PARTS	MATERIAL	QTY	FINISHING	THESE DRAWINGS AND SPECIFICATIONS ARE THE PROPERTY OF ACCURATE INNDTECH INC AND SHALL NOT BE REPRODUCED, COPIED OR USED IN ANY MANNER WITHOUT THE PRIOR WRITTEN CONSENT OF ACCURATE INNDTECH INC.		Q'TY	CHKD: gan 2012/6/29		SCALE	SHEET	REV.	CUSTOMER DRAWING
								1:1	1/1	B			