

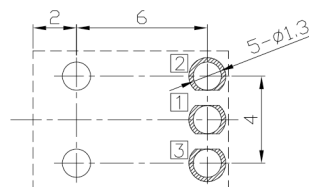

RoHS
Compliant
2002/95/EC

DIMENSIONS

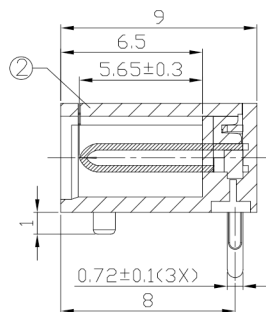
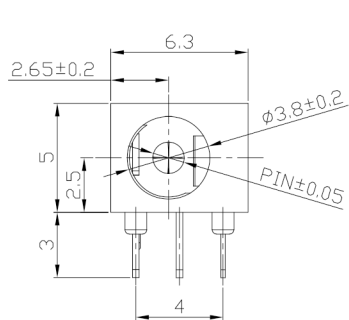

PCB HOLES(BOTTOM VIEW) t=1.6mm
NOTE:GENERAL TOLERANCE:±0.05mm

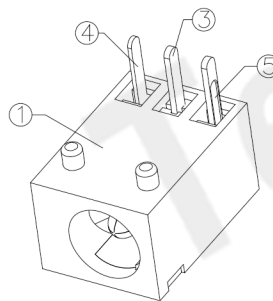
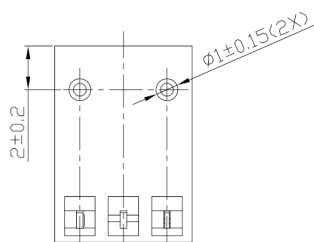

MODEL CODE:

DCB0-00030- A □ 66 BK S 0 4

- (1) (2) (3)(4) (5) (6) (7)(8) (9)
- (1):Series type:DIP DC POWER JACK.
(2):Series No.
(3):Schematic option: A , B
(4):Center pin diameter:
C=φ1.0 , E=φ1.3
(5):Material of housing:
9T=PA9T , 66=PA66
(6):Housing color:
BK=Black
(7):Terminal plating
S=Silver(Ag)
(8):Special option:
0=No special option
H=Halogen-free plastic
(9):Packing mode:
1=Tape & Rell Packing
3=Plastic box packing
4=Bag packing

Specification:

- Rating : DC 20V 2A.
- Contact resistance : ≤80mΩ
After test: ≤100mΩ
- Insulation resistance : ≥100MΩ (500VDC).
After test: ≥50MΩ
- Withstanding voltage: 500VAC .
- Insertion and extraction force: 3N~30N.
- life test: 5000cycles min.
- Operation temperature range:-20℃~70℃.
- Preservative temperature range:-40℃~85℃.

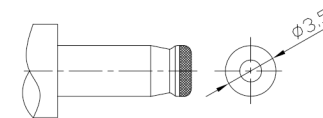
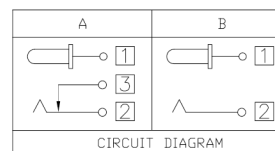

DC MATE PLUG

Model No.	C	E
CENTER PIN	φ1.0	φ1.3

○: ITEM NO. □: TERMINAL NO.

NO.	PARTS	MATERIAL	Q'TY	FINISHING	TOLERANCE	ANGLES	UNITS mm
⑤	Shunt terminal ③	Brass t=0.30	1	Silver Plating	±0.3	±2'	MAT'L
④	Tip spring ②	Stainless steel t=0.20	1	Silver Plating			SEE NOTE
③	Center pin ①	Brass t=0.30	1	Silver Plating			FINISH
②	Cover	Thermoplastic	1	Black			SEE NOTE
①	Housing	Thermoplastic	1	Black			Q'TY

THESE DRAWINGS AND SPECIFICATIONS ARE THE PROPERTY OF ACCURATE INNO TECH INC AND SHALL NOT BE REPRODUCED, COPIED OR USED IN ANY MANNER WITHOUT THE PRIOR WRITTEN CONSENT OF ACCURATE INNO TECH INC.



东莞市腾兴电子有限公司

TITLE: DIP DC POWER JACK PART NO.: DCB0-00030

DR: Ricky 2019/03/05 DWG NO.: AB0-00030

CHKD: Ricky 2019/03/05

APPD:

SCALE	SHEET	REV.	CUSTOMER DRAWING
1:1	1/1	A	