

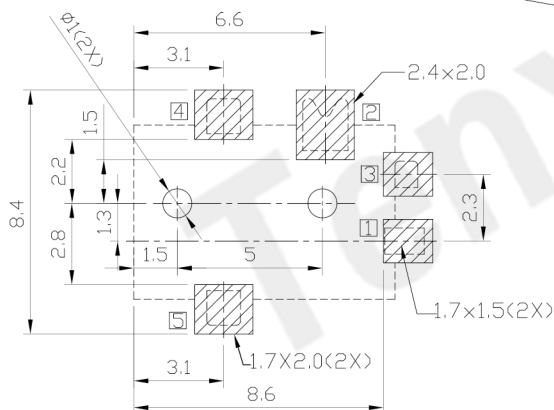

RoHS
Compliant
2002/95/EC

REV.	ECN.	NO.	APPD.

DIMENSIONS

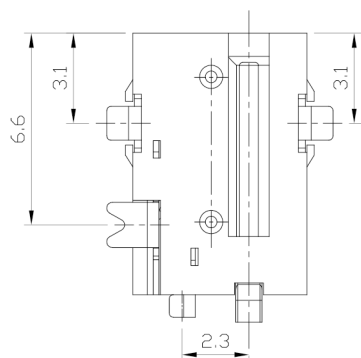
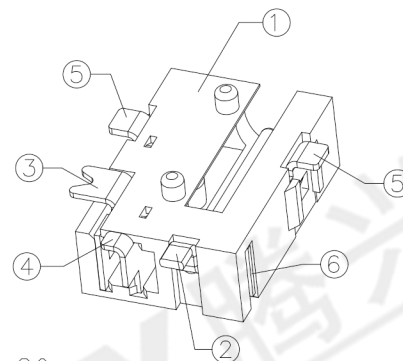
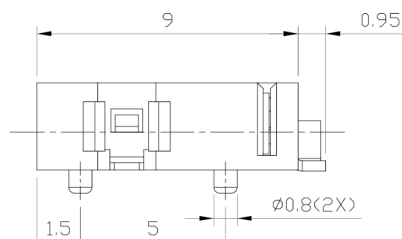
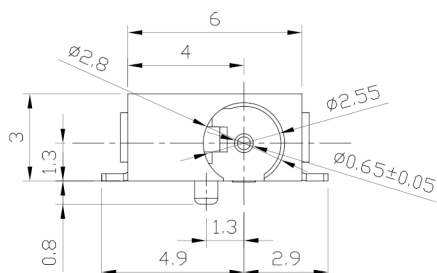

RECOMMENDED P.C.B. LAYOUT
UNSPECIFIED TOLERANCE:±0.05
(TOP VIEW)

MODEL CODE:

DCB0-00560- A A 9T BK S 0 1

(1) (2) (3)(4)(5) (6) (7)(8) (9)

(1):Series type:SMD DC POWER JACK.

(2):Series No.

(3):Schematic option: A,B

(4):Center pin diameter:

A=0.65

(5):Material of housing:

9T=PA9T(Standard), 10=PA10T

(6):Housing color:

BK=Black(Standard)

(7):Terminal plating:

S=Silver(Ag)

(8):Special option:

0=No special option

H=Halogen Free material

(9):Packing mode:

1=Reel packing

Specification:

1.Rating : DC 12V 1A;

2.Contact resistance: ≤30mΩ;

After test:≤50mΩ

3.Insulation resistance: ≥100MΩ (500VDC);

After test:≥50MΩ

4.Withstanding voltage: 500VAC ;

5.Insertion and extraction force: 3N~30N;

6.Life test: 5000 cycles min;

7.Operation temperature range:-20℃~70℃

8.Preservative temperature range:-40℃~85℃

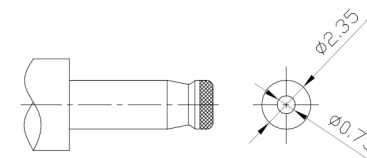
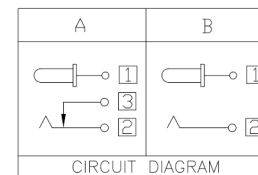

DC MATE PLUG

○: ITEM NO. □: TERMINAL NO.

NO.	PARTS	MATERIAL	Q'TY	FINISHING	TOLERANCE	ANGLES	UNITS
⑥	Cumber terminal	Copper alloy	1	Silver plating			mm
⑤	Contact terminal ④⑤	Copper alloy	2	Silver plating	±0.3	±2'	MAT'L
④	Shunt terminal ③	Copper alloy	1	Gold plating			SEE NOTE
③	Tip spring ②	Copper alloy	1	Gold plating			FINISH
②	Center pin ①	Copper alloy	1	Silver plating			SEE NOTE
①	Housing	High-temp Thermoplastic	1	Black			Q'TY

THESE DRAWINGS AND SPECIFICATIONS ARE THE PROPERTY OF ACCURATE INNOVATECH INC AND SHALL NOT BE REPRODUCED, COPIED OR USED IN ANY MANNER WITHOUT THE PRIOR WRITTEN CONSENT OF ACCURATE INNOVATECH INC.



东莞市腾兴电子有限公司

TITLE: SMD DC POWER JACK

PART NO.: DCB0-00560

DR: Ricky 2018/06/25

DWG NO.: AB0-00560

CHKD: Ricky 2018/06/25

APPD:

SCALE	SHEET	REV.	CUSTOMER DRAWING
1:1	1/1	A	