

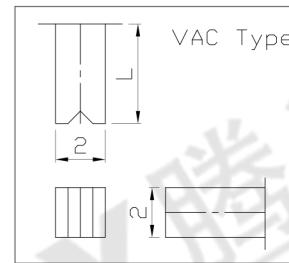

**RoHS Compliant**  
2002/95/EC

|      |      |     |       |
|------|------|-----|-------|
| REV. | ECN. | NO. | APPD. |
|      |      |     |       |
|      |      |     |       |

### DIMENSIONS

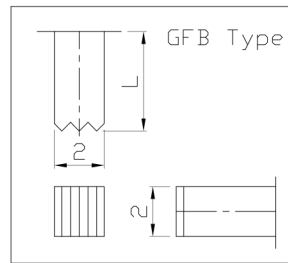
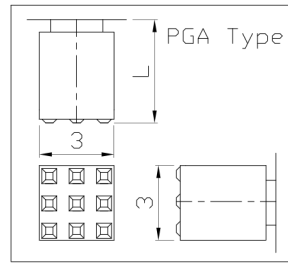
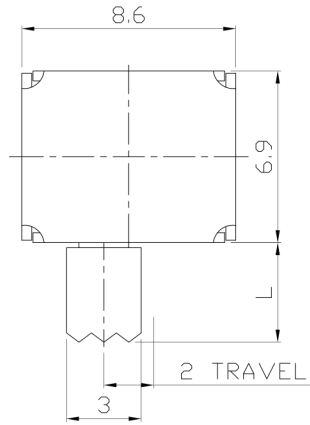

### MODEL CODE

SK-22D03-GEI

| Knob Type |
|-----------|
| GEI       |
| PGA       |
| GFB       |
| VAC       |

| L(mm) |
|-------|
| ~     |

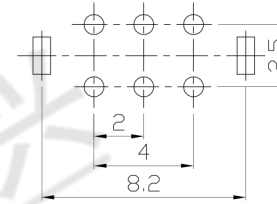

P.C.B LAYOUT  
BOTTOM VIEW

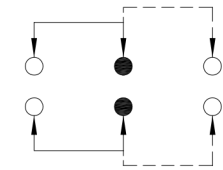

CIRCUIT DIAGRAM

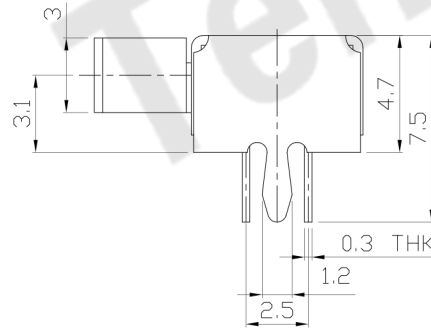
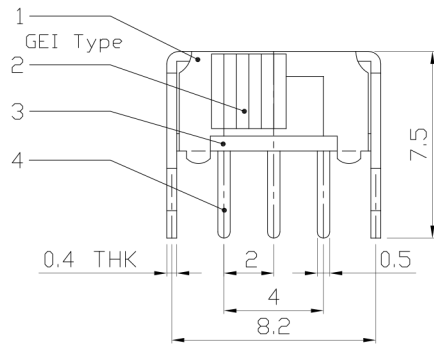

### ELECTRO-MECHANICAL CHARACTERISTICS

Refer to additional specifications

|                        |             |
|------------------------|-------------|
| RATING                 | 0.3A 50V DC |
| CIRCUIT                | 2P2T        |
| CONTACT RESISTANCE     | 100mΩ MAX.  |
| TIMING                 | NO SHORTING |
| TRAVEL                 | 2mm         |
| OPERATING FORCE        | 300±100gf   |
| OPERATING LIFE(cycles) | 10,000      |

|     |              |                |      |           |  |
|-----|--------------|----------------|------|-----------|--|
| 8   |              |                |      |           |  |
| 7   |              |                |      |           |  |
| 6   | SPRING PLATE | PBS STRIP      | 1    | NATURAL   |  |
| 5   | CONTACT CLIP | PBS STRIP      | 2    | Ag PLATED |  |
| 4   | TERMINAL     | BRASS STRIP    | 6    | Ag PLATED |  |
| 3   | BASE         | PHENOLIC RESIN | 1    | NATURAL   |  |
| 2   | KNOB         | PDM            | 1    | BLACK     |  |
| 1   | FRAME        | STEEL STRIP    | 1    | Ni PLATED |  |
| NO. | PARTS        | MATERIAL       | Q'TY | FINISHING |  |

|                      |          |
|----------------------|----------|
| WITHIN 1.5mm: ±0.1mm | UNITS mm |
| OVER 1.5mm: ±0.2mm   | MAT'L    |
|                      | SEE NOTE |
|                      | FINISH   |
|                      | SEE NOTE |
|                      | Q'TY     |
|                      |          |

THESE DRAWINGS AND SPECIFICATIONS ARE THE PROPERTY OF ACCURATE INNO TECH INC AND SHALL NOT BE REPRODUCED, COPIED OR USED IN ANY MANNER WITHOUT THE PRIOR WRITTEN CONSENT OF ACCURATE INNO TECH INC.

### 东莞市腾兴电子有限公司

|        |                           |                  |           |
|--------|---------------------------|------------------|-----------|
| TITLE: | SLIDE SWITCH / HORIZONTAL | PART NO.:        | SK-22D03  |
| DR:    | Ricky 2016/06/24          | DWG NO.:         | ADL-22D03 |
| CHKD:  | Ricky 2016/06/24          | SCALE            | SHEET     |
| APPD:  |                           | 4:1              | 1/1       |
|        |                           | REV.             | A         |
|        |                           | CUSTOMER DRAWING |           |