

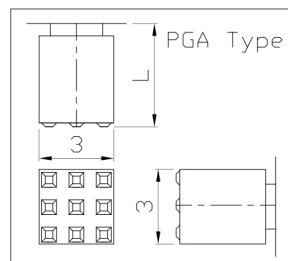

RoHS Compliant
2002/95/EC

REV.	ECN. NO.	APPD.

DIMENSIONS

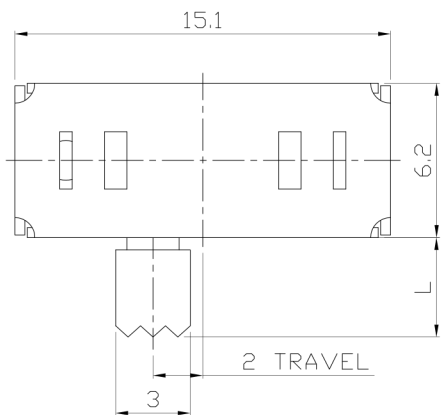

MODEL CODE

SK-23D08-GEI

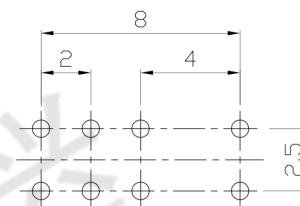
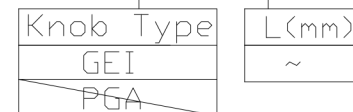

P.C.B LAYOUT
BOTTOM VIEW

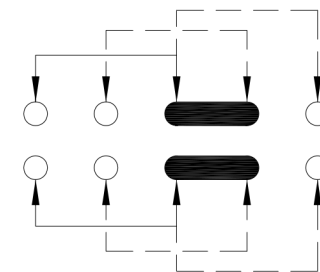

CIRCUIT DIAGRAM

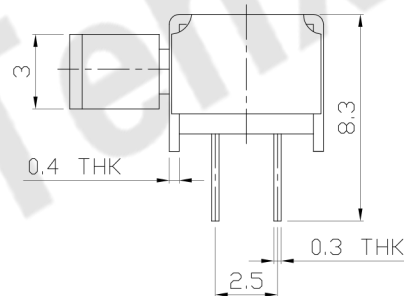
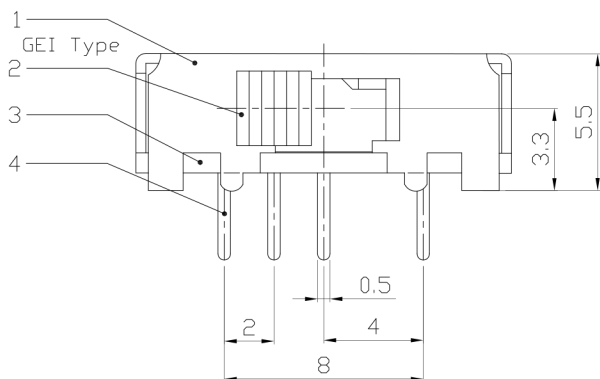

ELECTRO-MECHANICAL CHARACTERISTICS

Refer to additional specifications

RATING	0.3A 50V DC
CIRCUIT	2P3T
CONTACT RESISTANCE	100mΩ MAX.
TIMING	NON-SHORTING
TRAVEL	2mm
OPERATING FORCE	250±100gf
OPERATING LIFE(cycles)	10,000

8						
7						
6	SPRING PLATE	SUS	1	NATURAL	WITHIN 1.5mm: ±0.1mm	UNITS mm
5	CONTACT CLIP	PBS STRIP	2	Ag PLATED	OVER 1.5mm: ±0.2mm	MAT'L
4	TERMINAL	BRASS STRIP	8	Ag PLATED		SEE NOTE
3	BASE	PHENOLIC RESIN	1	NATURAL		FINISH
2	KNOB	POM	1	BLACK		SEE NOTE
1	FRAME	STEEL STRIP	1	Ni PLATED		Q'TY
NO.	PARTS	MATERIAL	Q'TY	FINISHING		

THESE DRAWINGS AND SPECIFICATIONS ARE THE PROPERTY OF ACCURATE INNO TECH INC AND SHALL NOT BE REPRODUCED, COPIED OR USED IN ANY MANNER WITHOUT THE PRIOR WRITTEN CONSENT OF ACCURATE INNO TECH INC.



东莞市腾兴电子有限公司

TITLE:	SLIDE SWITCH / HORIZONTAL	PART NO.:	SK-23D08
DR:	Ricky 2016/07/11	DWG NO.:	ADL-23D08
CHKD:	Ricky 2016/07/11	SCALE	3:1
APPD:		SHEET	1/1
		REV.	A
		CUSTOMER DRAWING	