

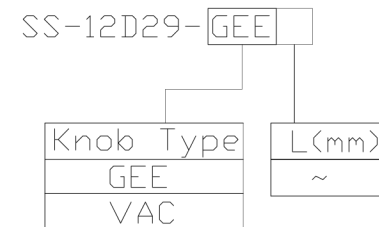

RoHS
Compliant
2002/95/EC

REV.	ECN.	NO.	APPD.

MODEL CODE



DIMENSIONS

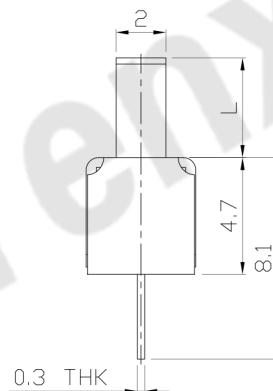
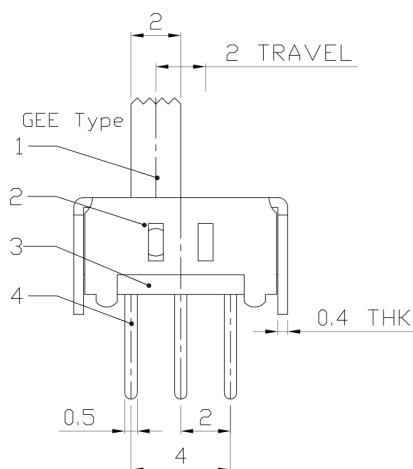
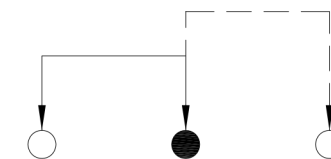
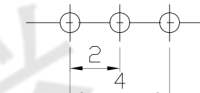
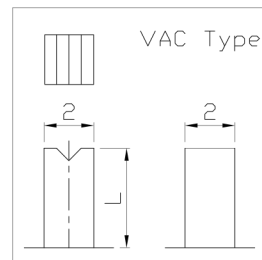
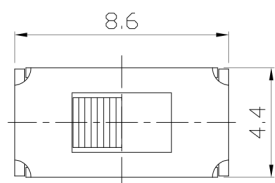

ELECTRO-MECHANICAL CHARACTERISTICS

Refer to additional specifications

RATING	0.3A 50V DC
CIRCUIT	1P2T
CONTACT RESISTANCE	30mΩ MAX.
TIMING	NON-SHORTING
TRAVEL	2mm
OPERATING FORCE	250±100gf
OPERATING LIFE(cycles)	10,000

8					WITHIN 1.5mm: ±0.1mm	UNITS	mm	东莞市腾兴电子有限公司 TITLE: SLIDE SWITCH / VERTICAL PART NO.: SS-12D29 DR: Ricky 2015/06/09 DWG NO.: ADJ-12D29 CHKD: Ricky 2015/06/09 APPD:
7					OVER 1.5mm: ±0.2mm	MAT'L		
6	SPRING PLATE	SUS	1	NATURAL		SEE NOTE		
5	CONTACT CLIP	PBS C5210R-EH	1	Ag CLAD				
4	TERMINAL	BRASS STRIP	3	Ag PLATED OVER Ni PLATED		FINISH		
3	BASE	PHENOLIC RESIN	1	NATURAL		SEE NOTE		
2	FRAME	STEEL STRIP	1	Ni PLATED		Q'TY		
1	KNOB	POM	1	BLACK				
NO.	PARTS	MATERIAL	Q'TY	FINISHING				SCALE SHEET REV. CUSTOMER DRAWING
								4:1 1/1 A

THESE DRAWINGS AND SPECIFICATIONS ARE THE PROPERTY OF ACCURATE INNOVATION INC AND SHALL NOT BE REPRODUCED, COPIED OR USED IN ANY MANNER WITHOUT THE PRIOR WRITTEN CONSENT OF ACCURATE INNOVATION INC.

